

THE FIERY FURNACE

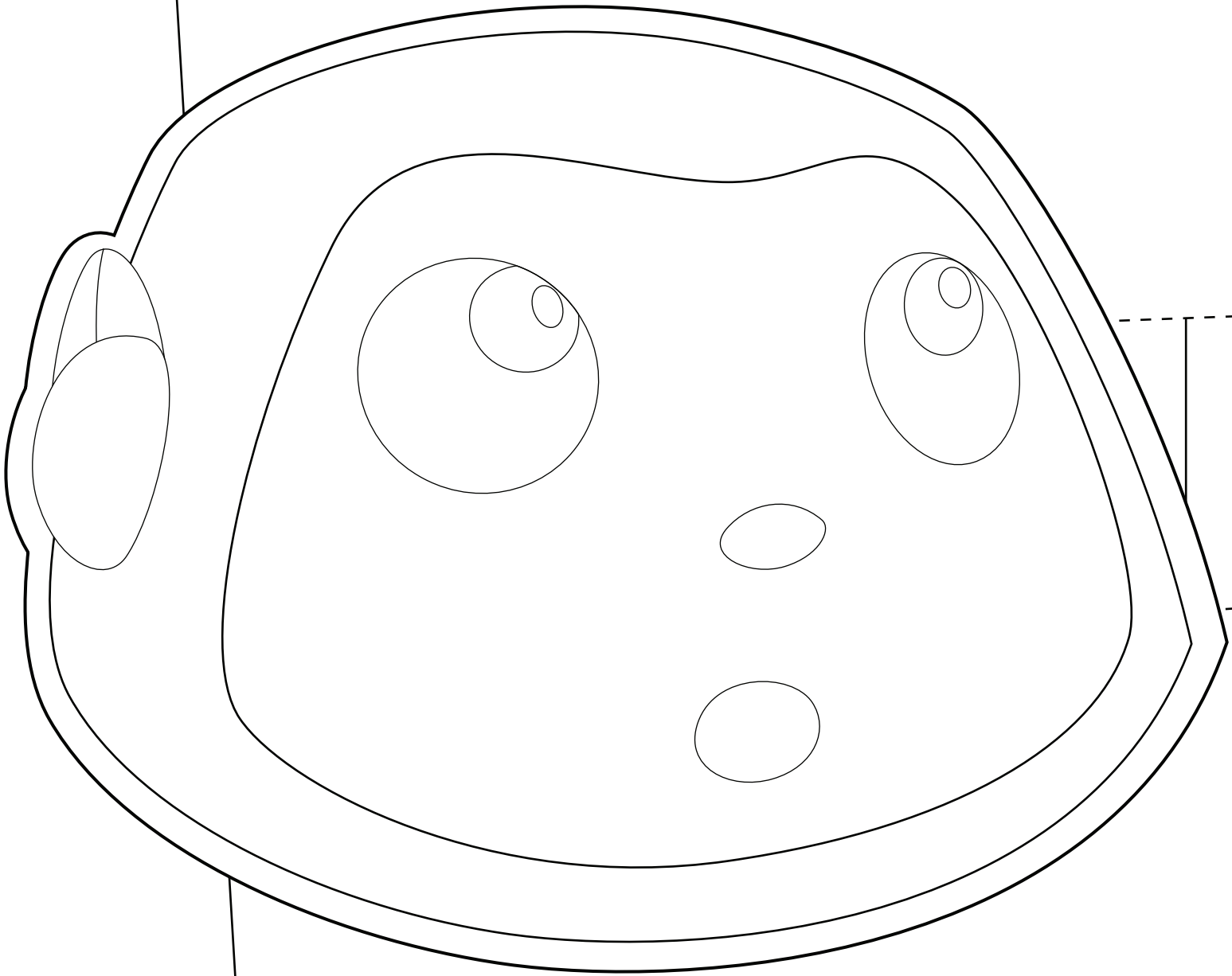

STEM ACTIVITY

WHAT YOU NEED

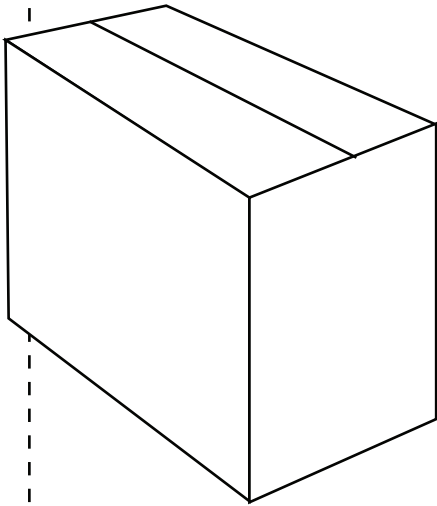

TISSUE PAPER

You can use any small box.

LAMP OR FLASHLIGHT

A lamp would work best.

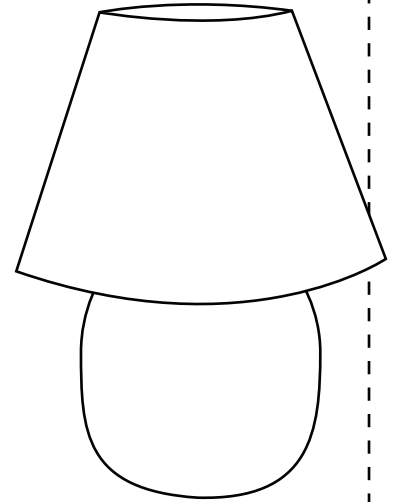

SCISSORS, TAPE AND GLUE

We recommend using safety scissors.

POPSICLE STICKS

Used as supports for the paper shapes.

PAPER SHAPES

Use scissors to cut out shapes like a heart, a cross, or a mountain.

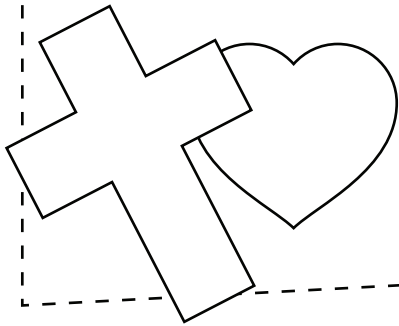

DIRECTIONS

STEP 1

Use the scissors, tape and glue to construct the box to the left. (Cut out the back of the box) Make sure that light only shines through the box one way – through the side tab. Ask an adult for help if your having trouble cutting the square in the side of the box. You can paint and decorate the box if you'd like!

STEP 2

Glue or tape the paper shapes onto the popsicle sticks. Then turn the flashlight on and place it in the box.

STEP 3

Place the lamp behind the box and turn it on. Move the lamp closer or further until you, can see shadows on the outer screen.

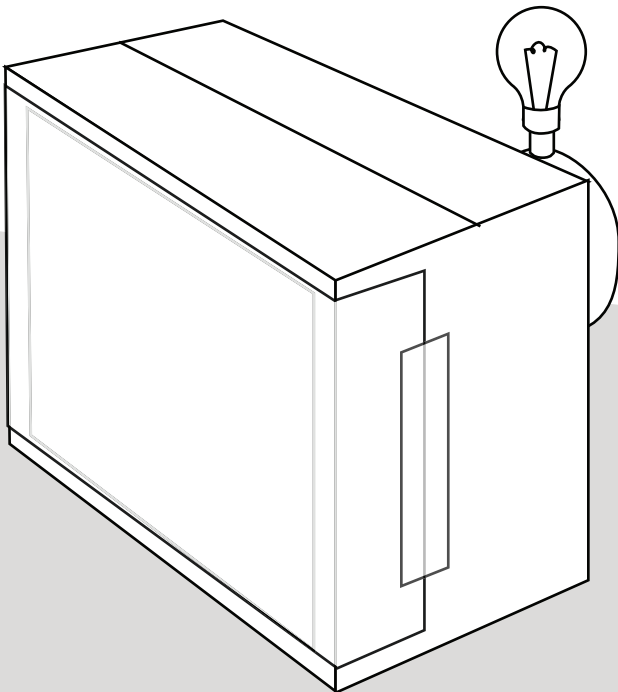

SHAPES

Here are some shapes you can cut out for the show!

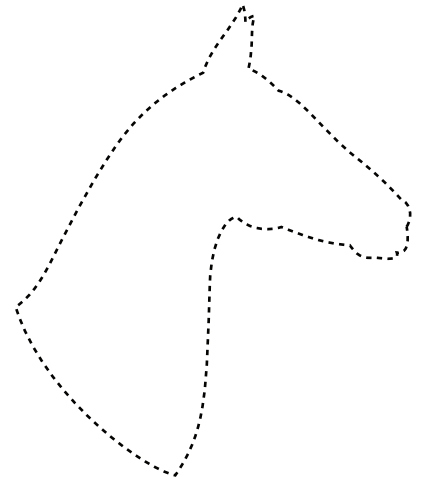
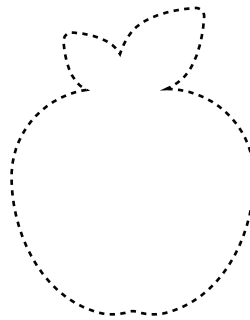
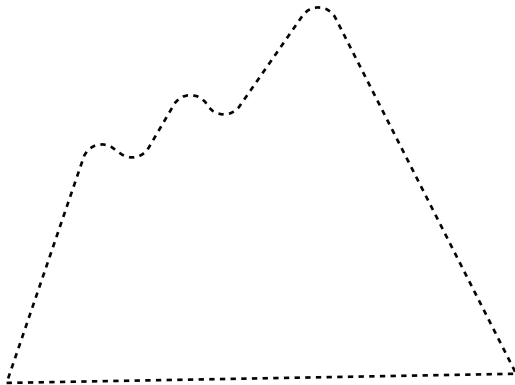
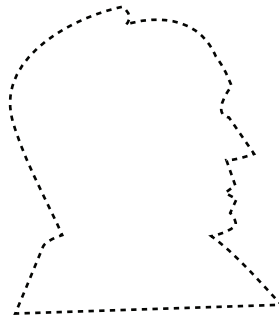
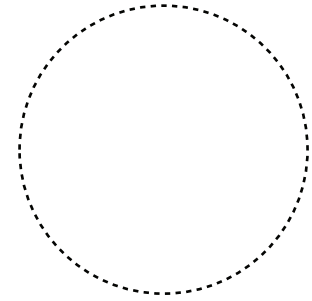
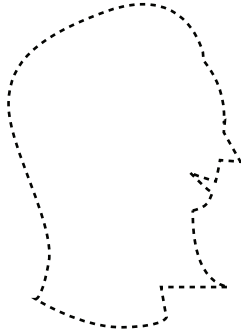
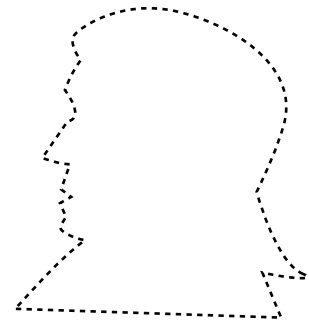
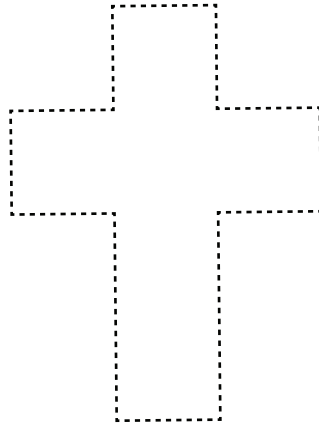
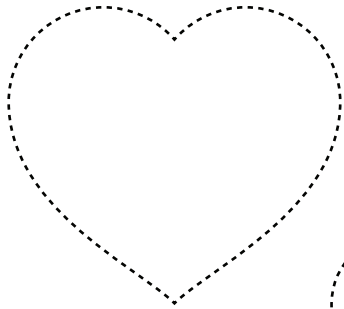

SHOWTIME!

Get behind the box with your puppets and use your the puppets to tell the story of Jesus.

